

# DIE-CUT PATTERNS

# AIR TRACTOR AT802

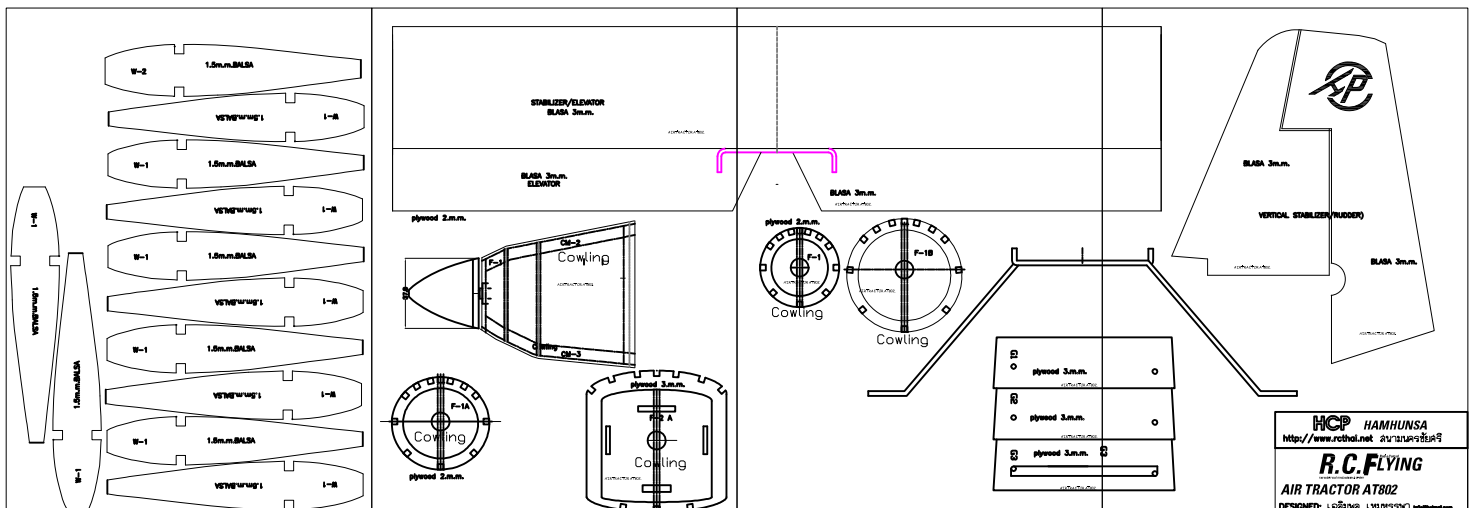

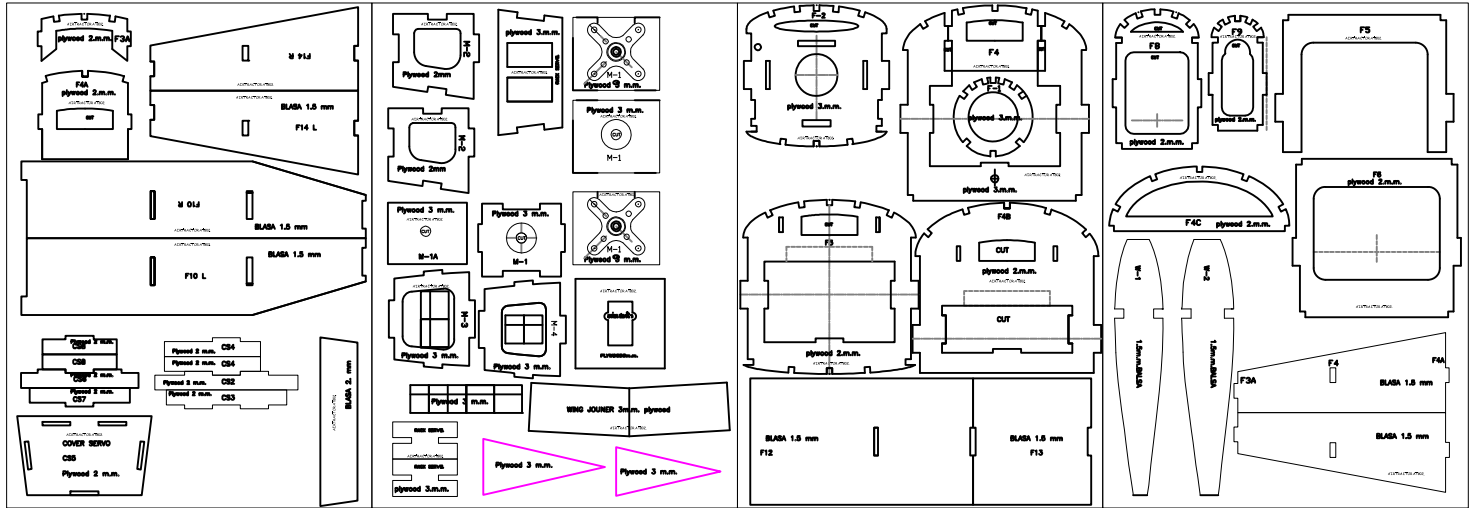
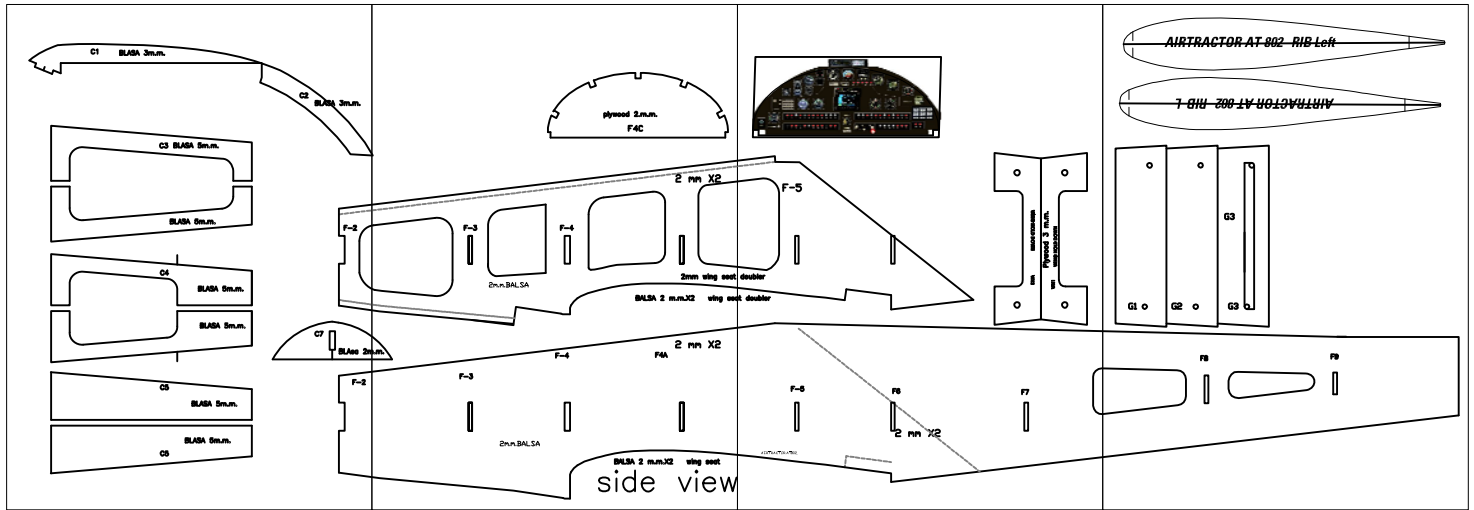
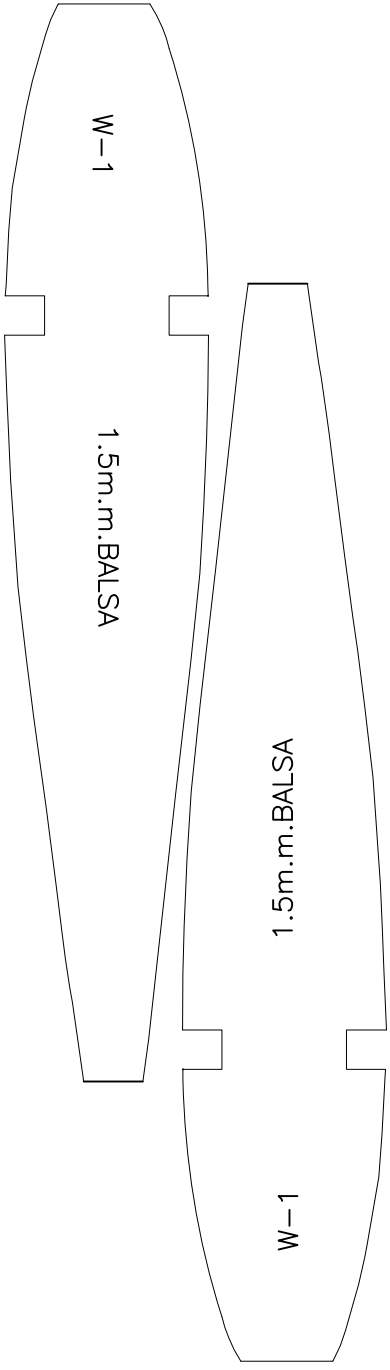
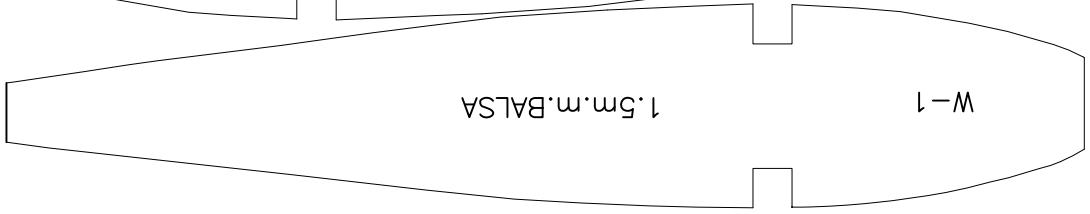
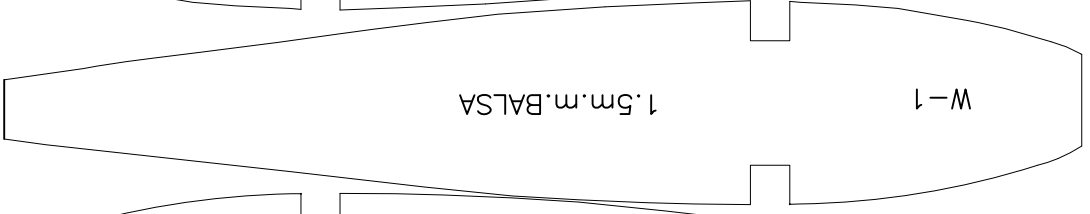
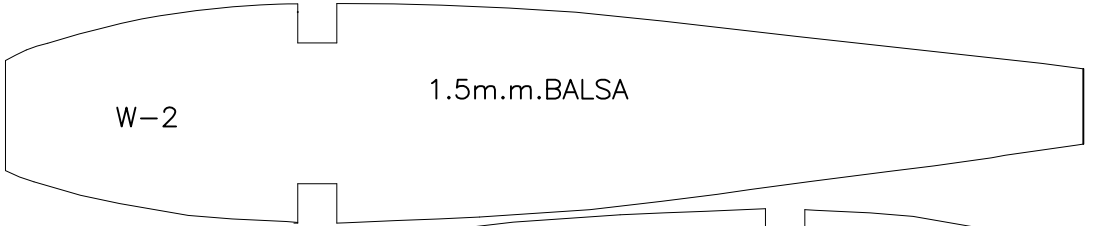

STABILIZER/ELEVATOR  
BLASA 3m.m.

AIRTRACTOR AT802

BLASA 3m.m.  
ELEVATOR

plywood 2.m.m.

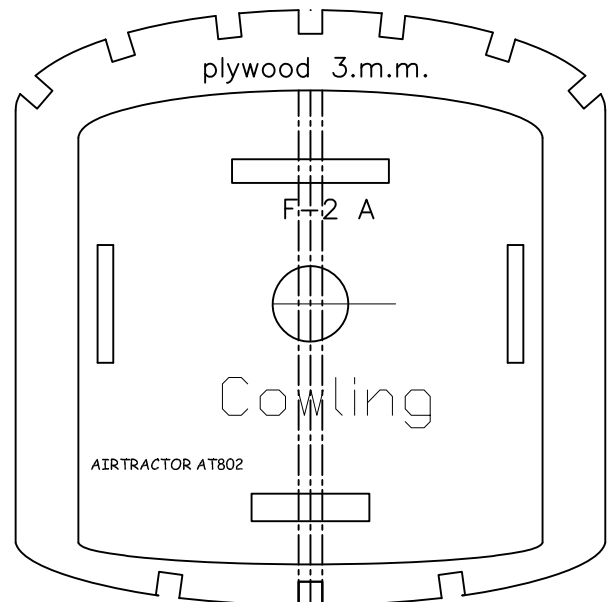
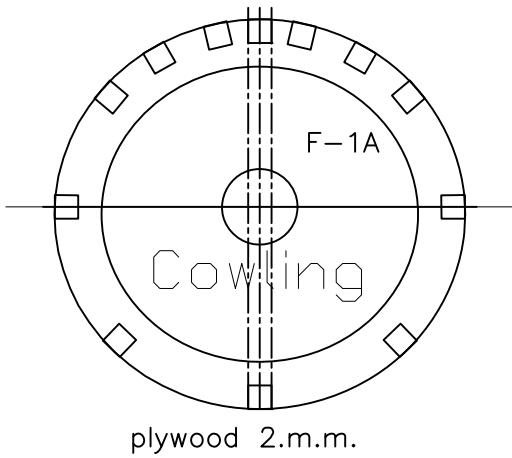
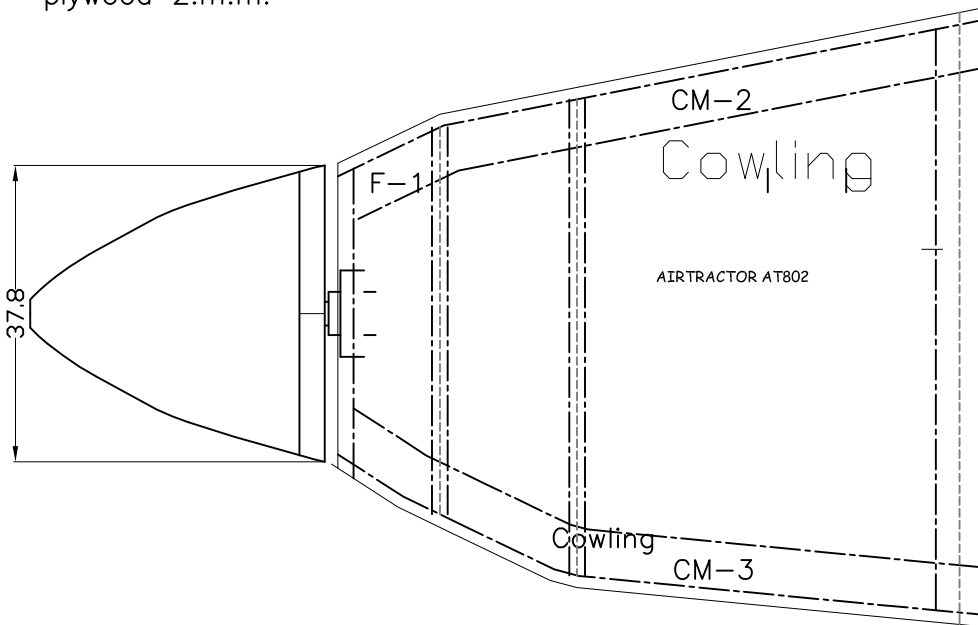

BLASA 3m.m.

AIRTRACTOR AT802

plywood 2.m.m.

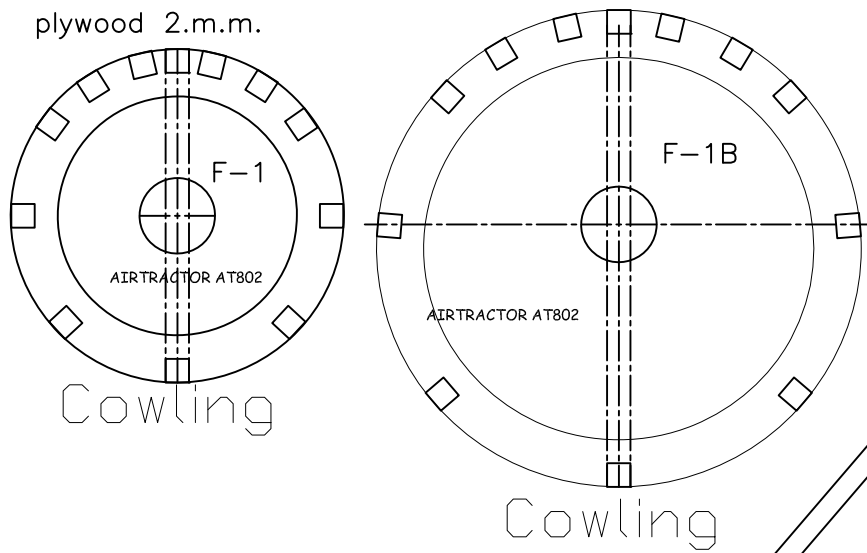

Cowling

Cowling

G1  
O

plywood 3.m.m.

AIRTRACTOR AT802

G2  
O

plywood 3.m.m.

AIRTRACTOR AT802

G3  
O

plywood 3.m.m.

AIRTRACTOR AT802

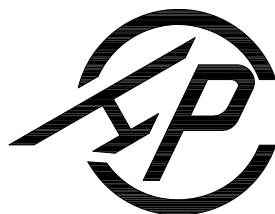

BLASA 3m.m.

VERTICAL STABILIZER (RUDDER)

AIRTRACTOR AT802

BLASA 3m.m.

AIRTRACTOR AT802

HCP **HAMHUNSA**

<http://www.rcthai.net> สานามนครชัยศรี

**R.C. FLYING**  
Radio Control  
THE MOST EXCITING HOBBY & SPORT

**AIR TRACTOR AT802**

DESIGNED: เฉฉิมพล เหมพรธษา [hs7e@hotmail.com](mailto:hs7e@hotmail.com)

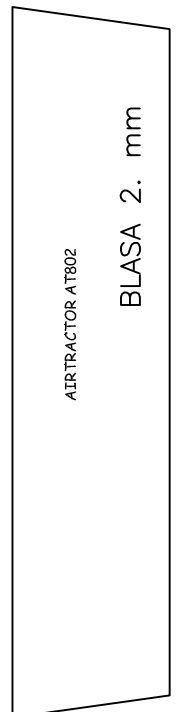
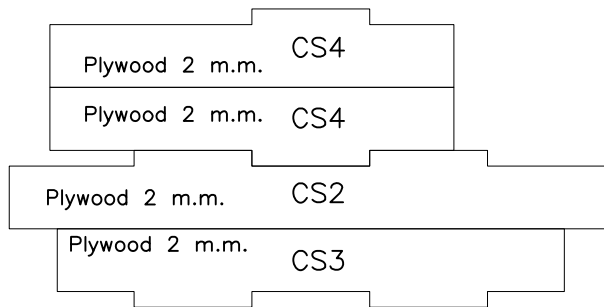
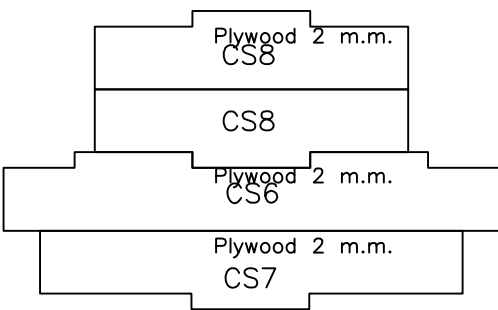
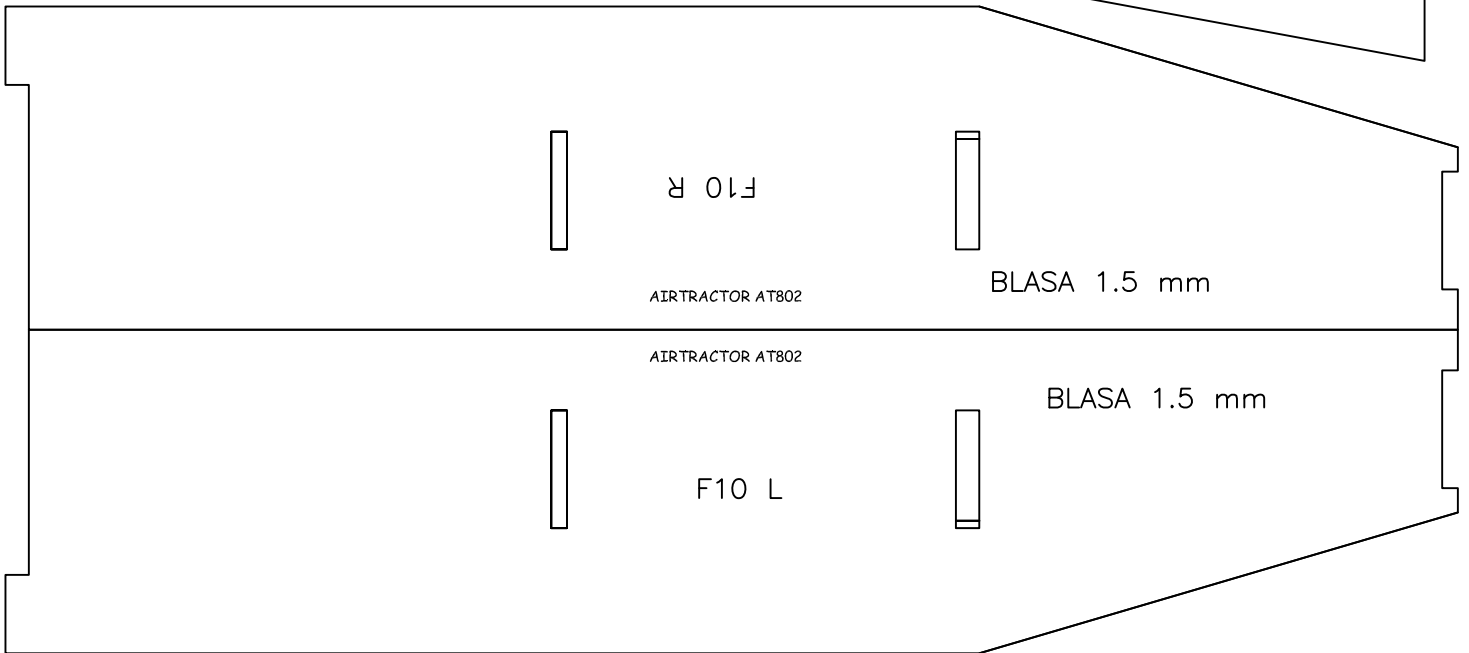
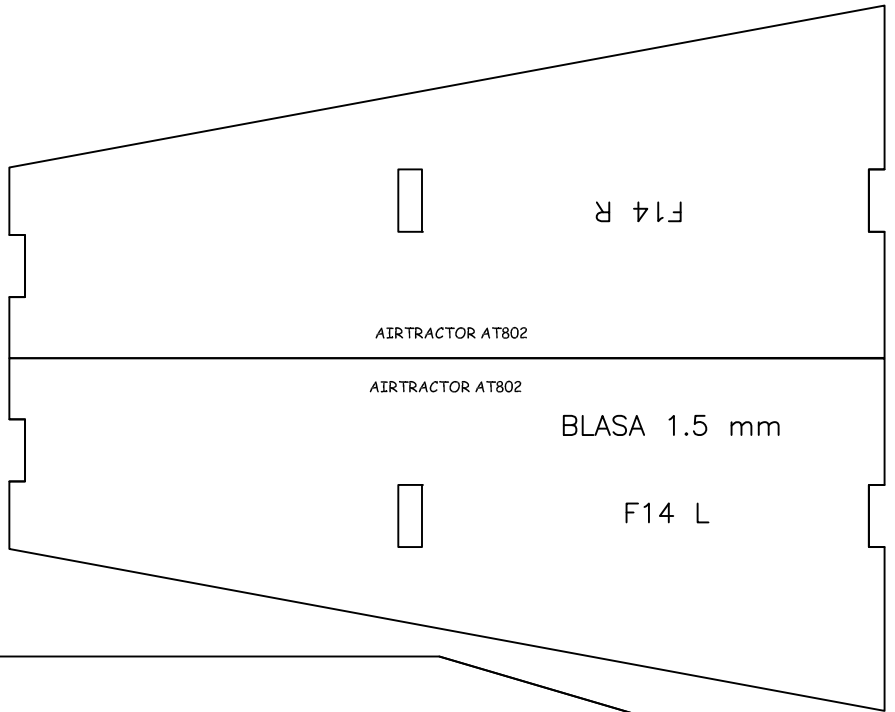
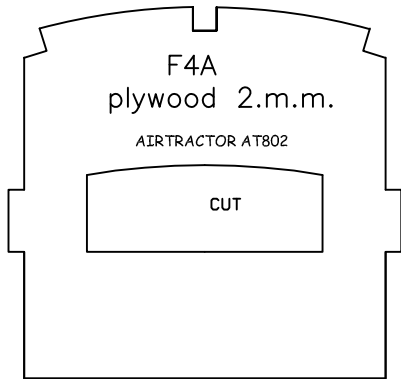
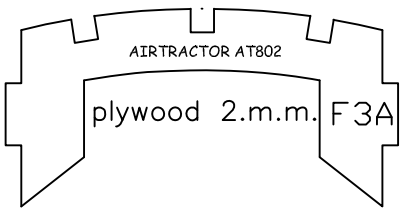

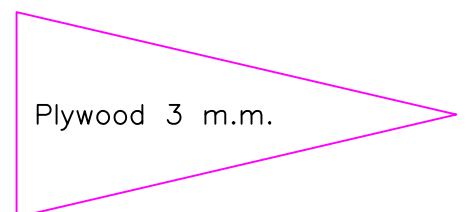
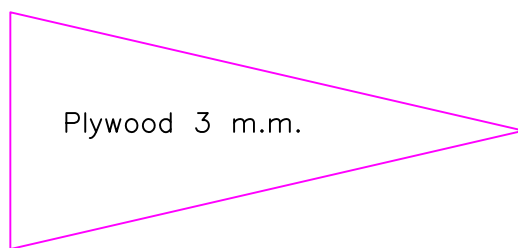
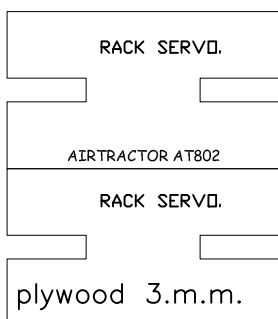
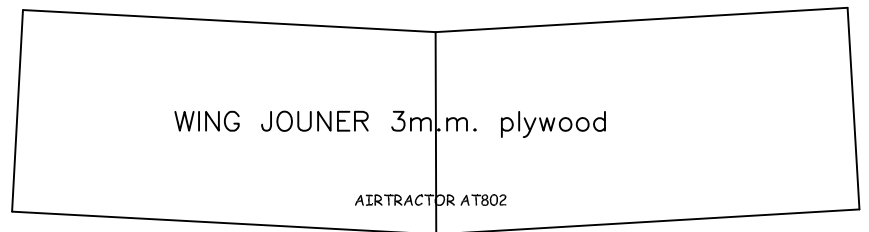
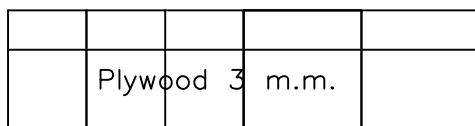
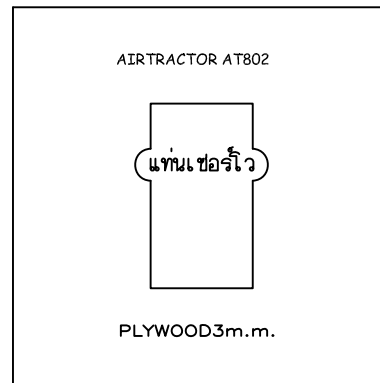
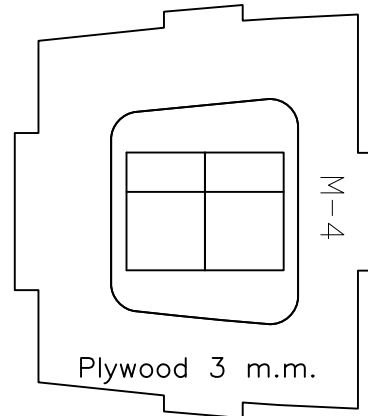
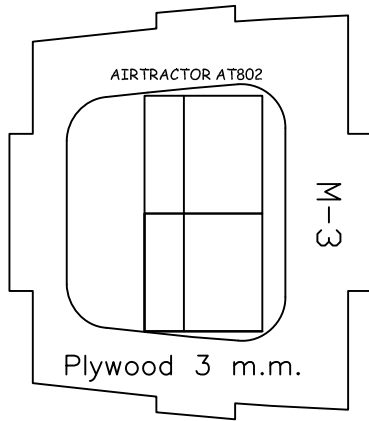
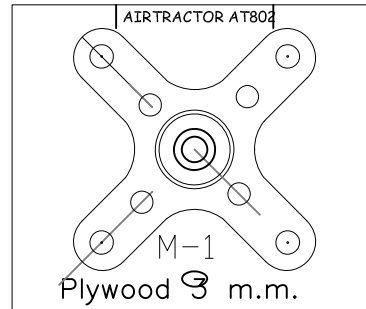
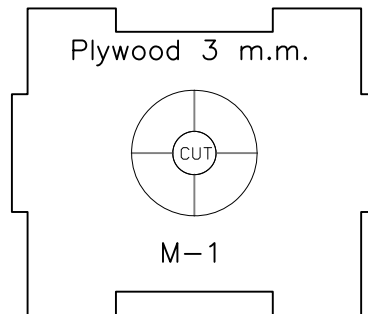
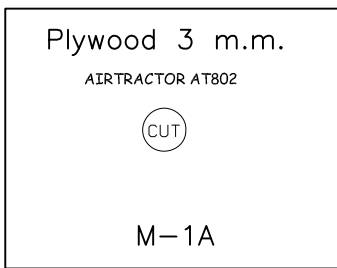
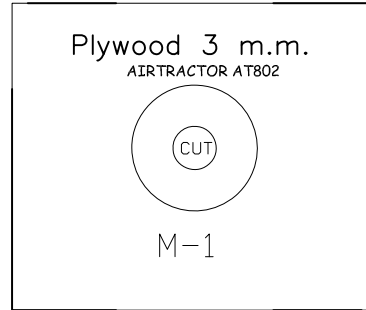
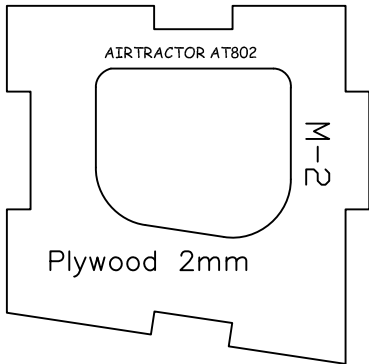
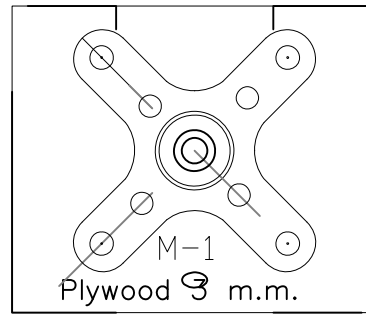
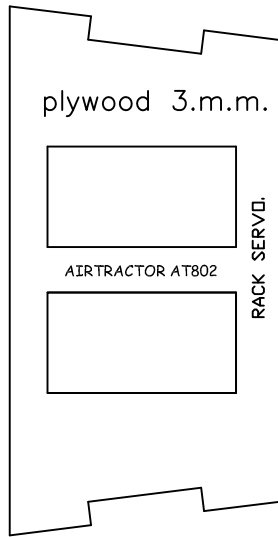
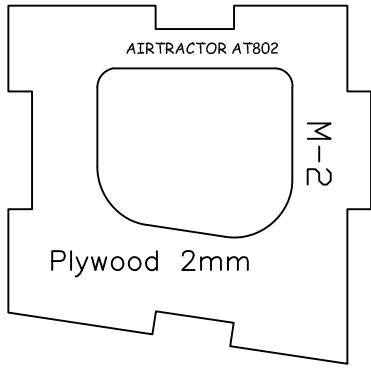

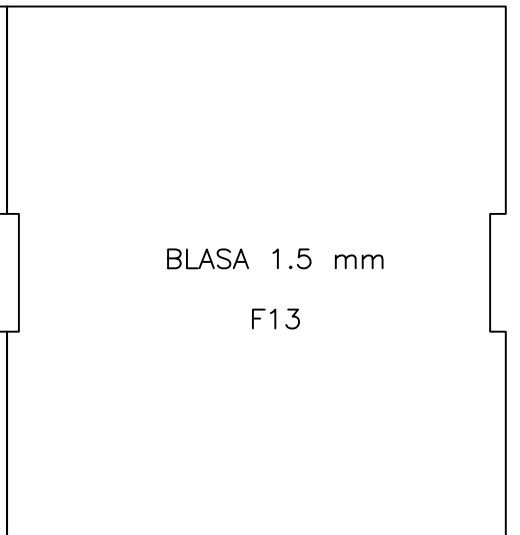
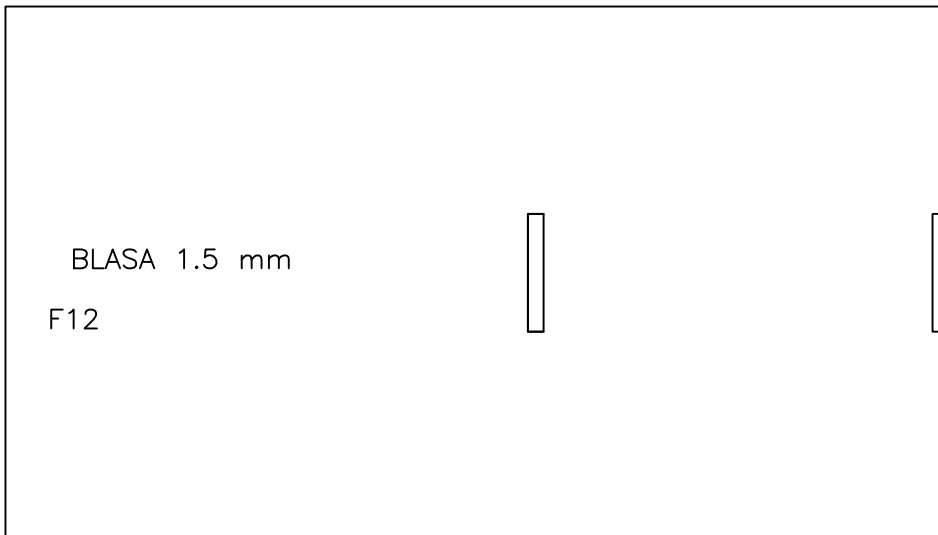
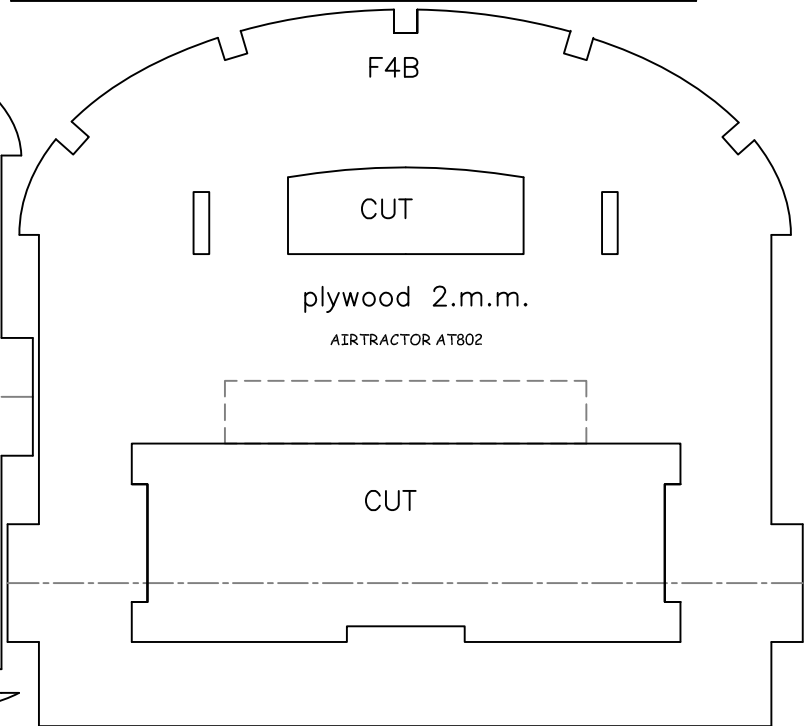
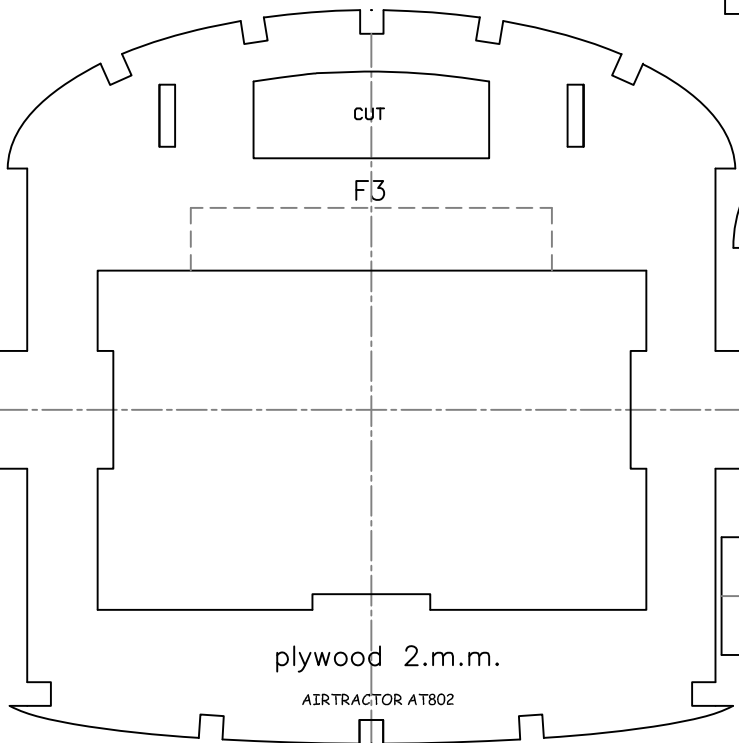
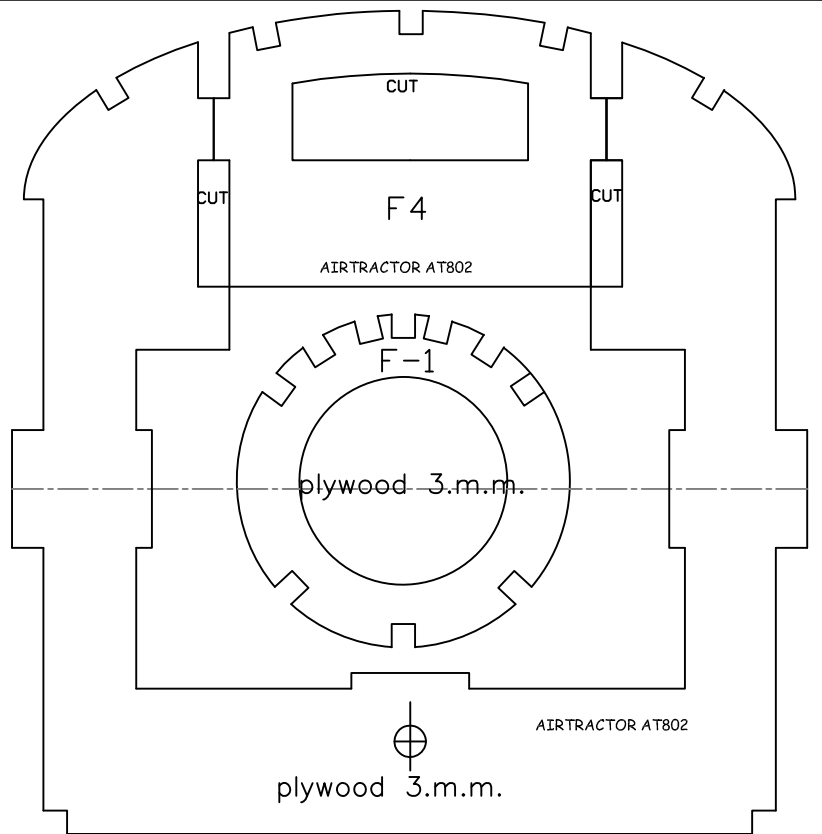
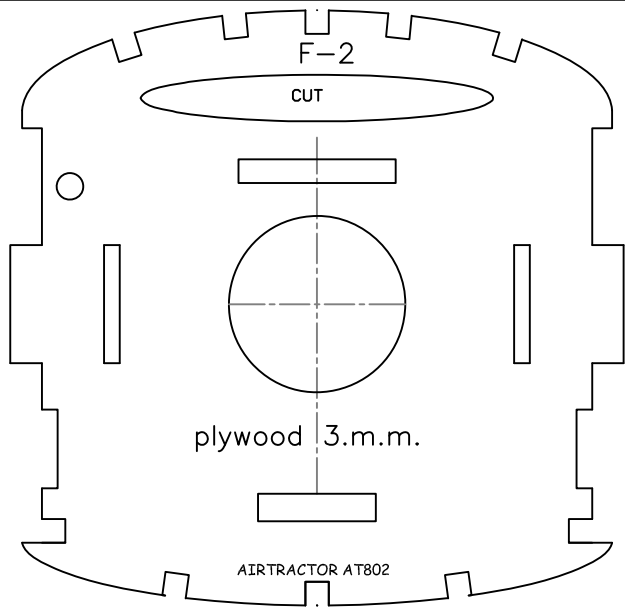

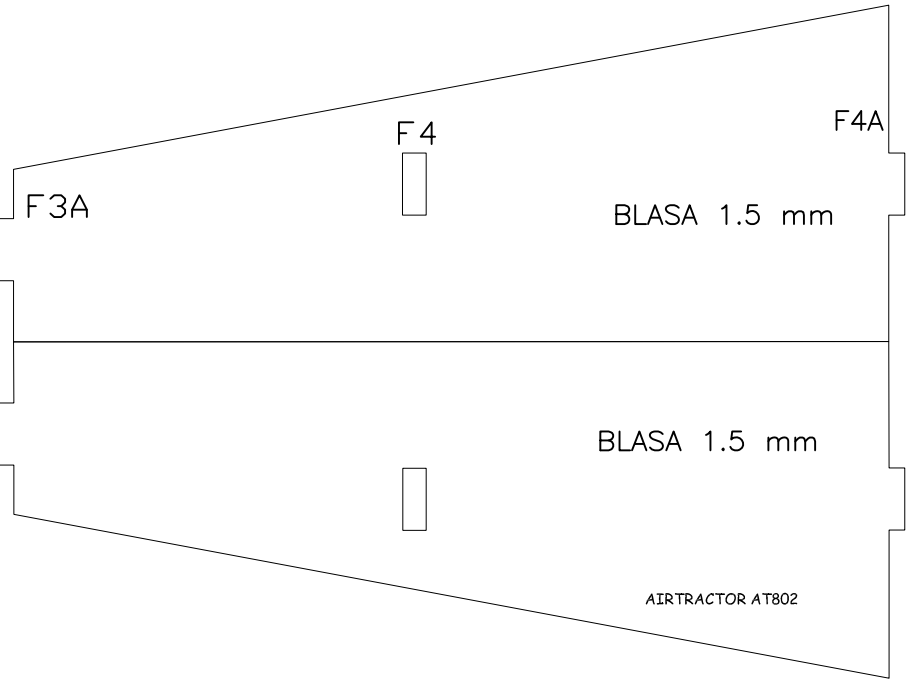
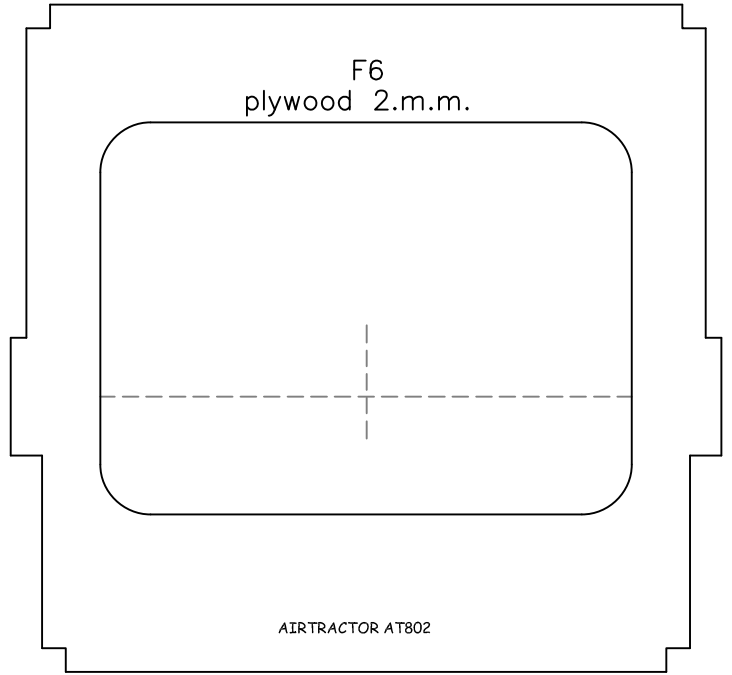
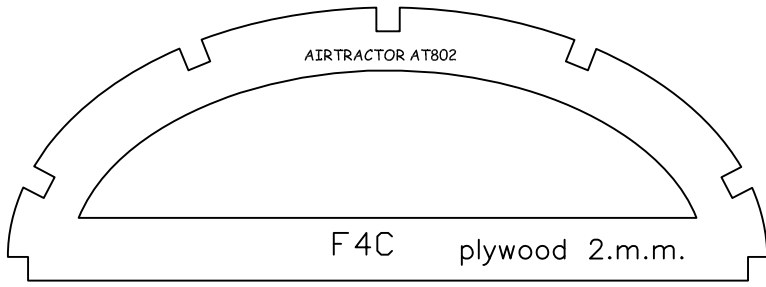
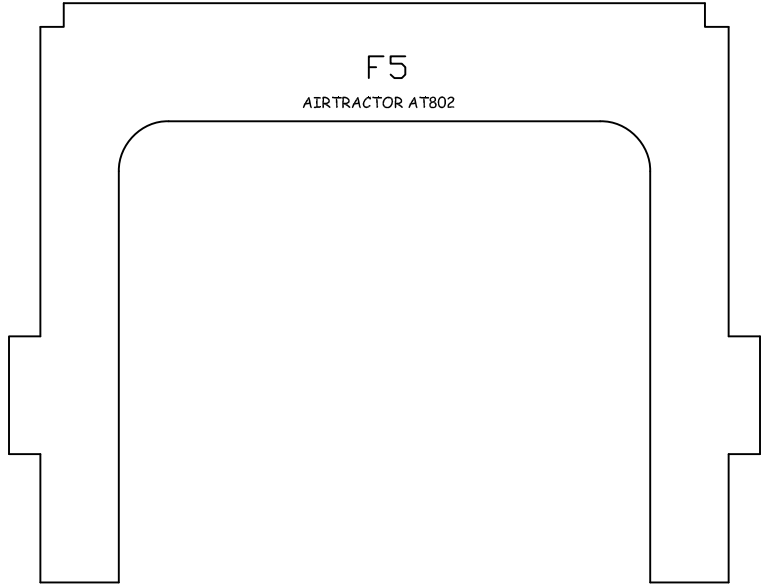
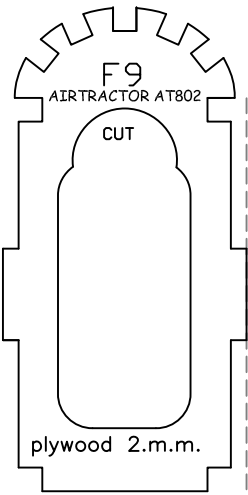
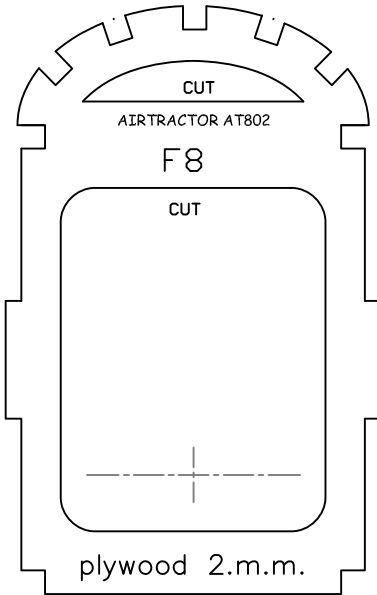

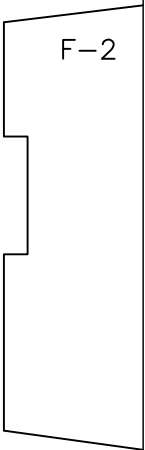
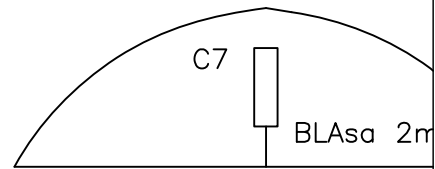
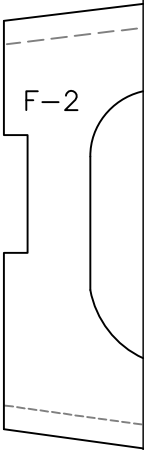
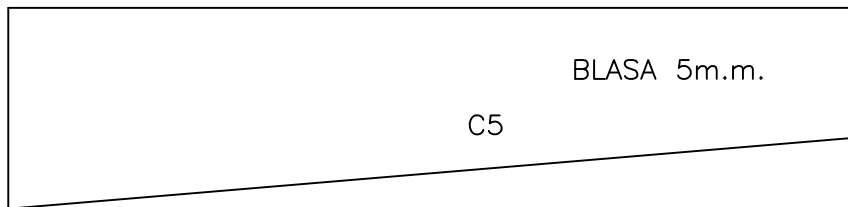
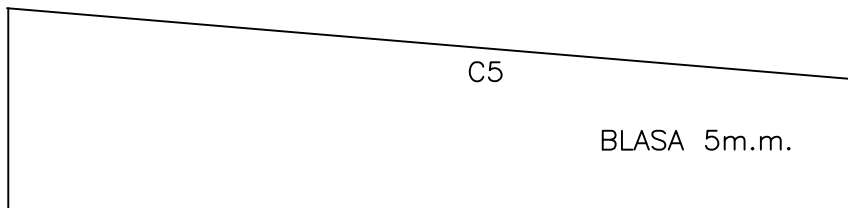
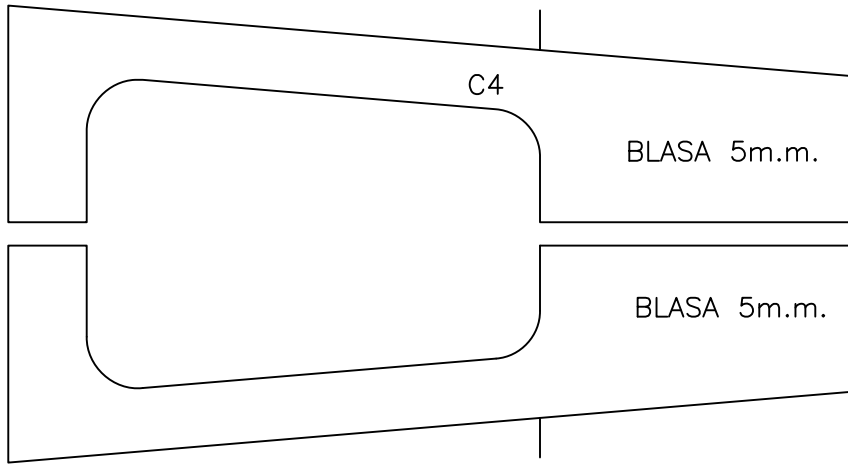
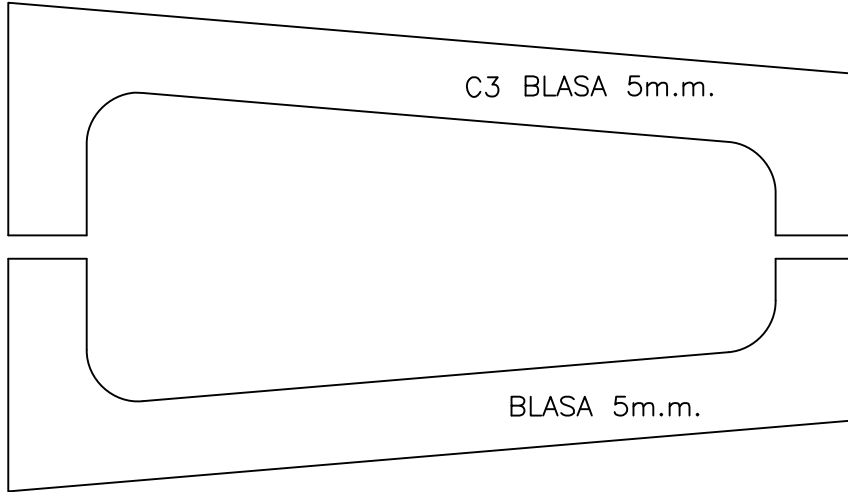
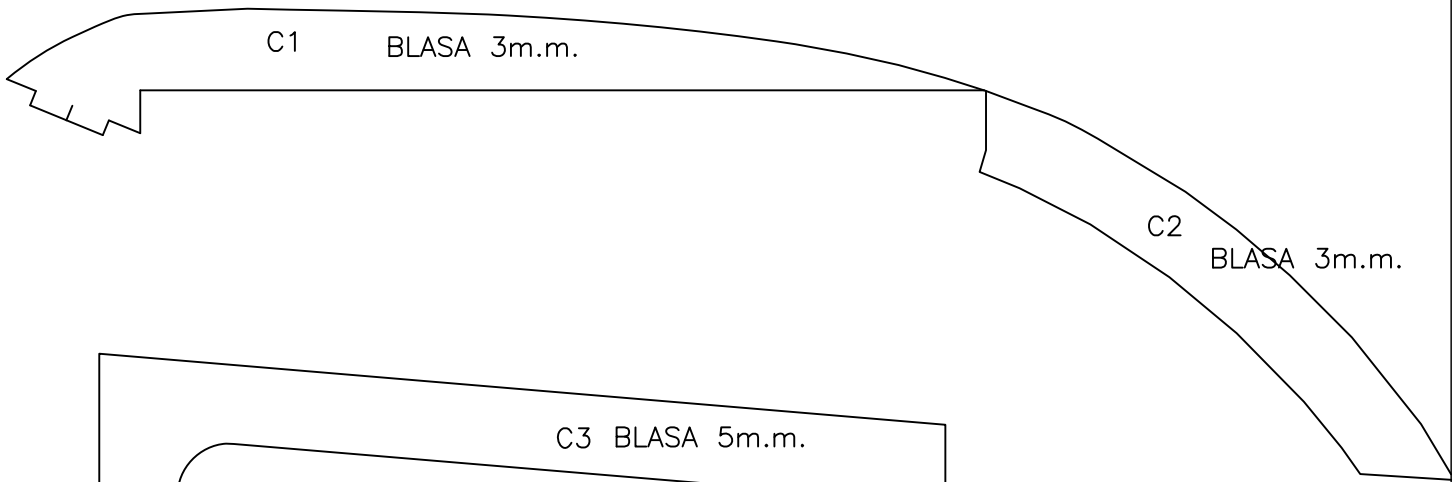

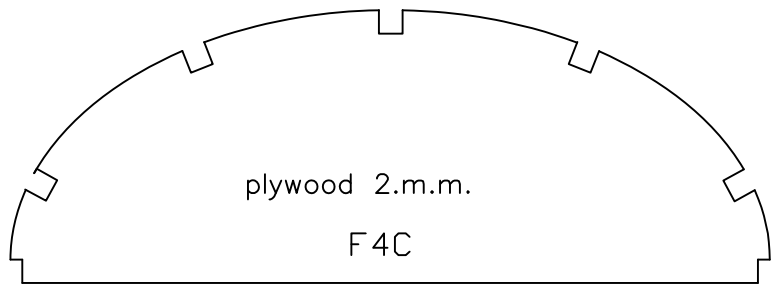

plywood 2.m.m.  
F4C

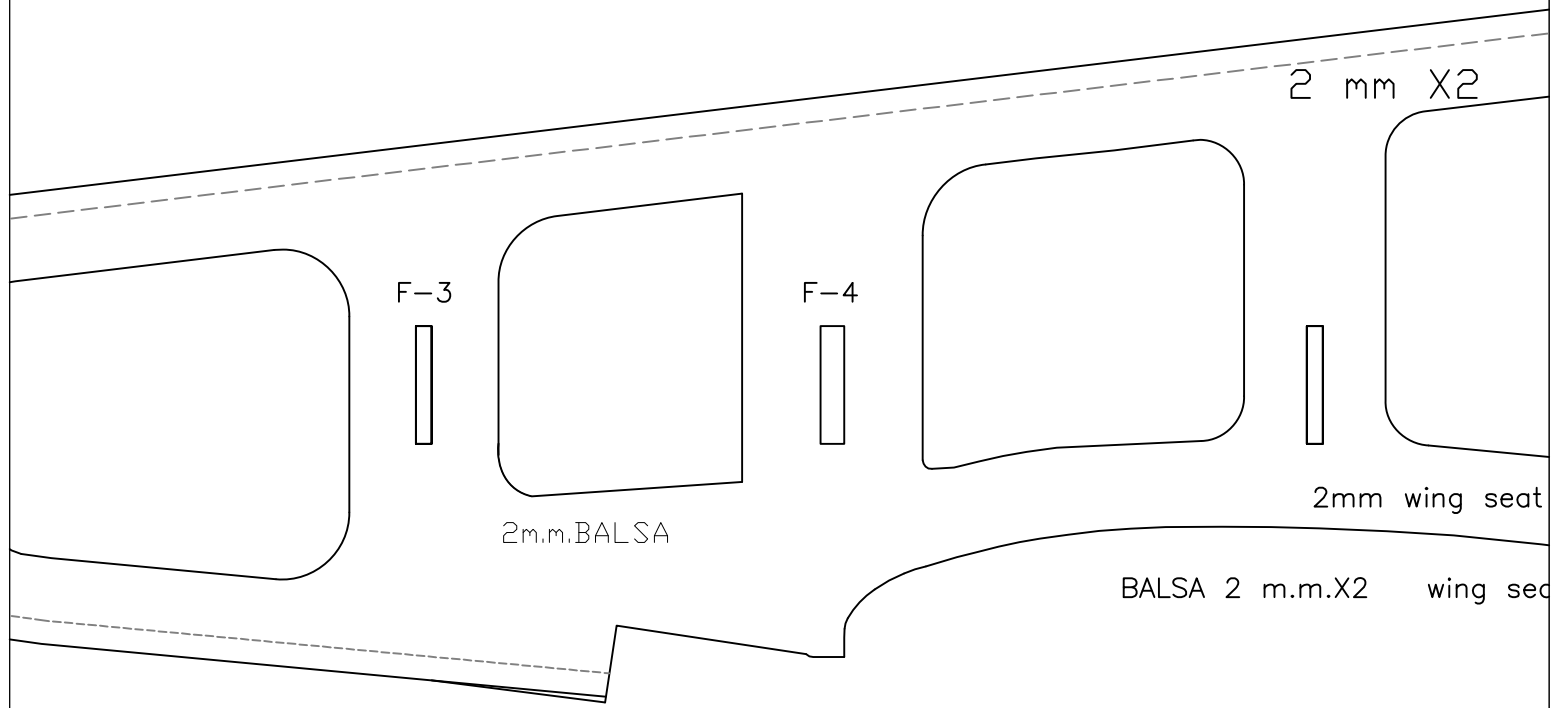

2 m.m X2

F-3

F-4

2m.m.BALSA

2mm wing seat

BALSA 2 m.m.X2 wing sec

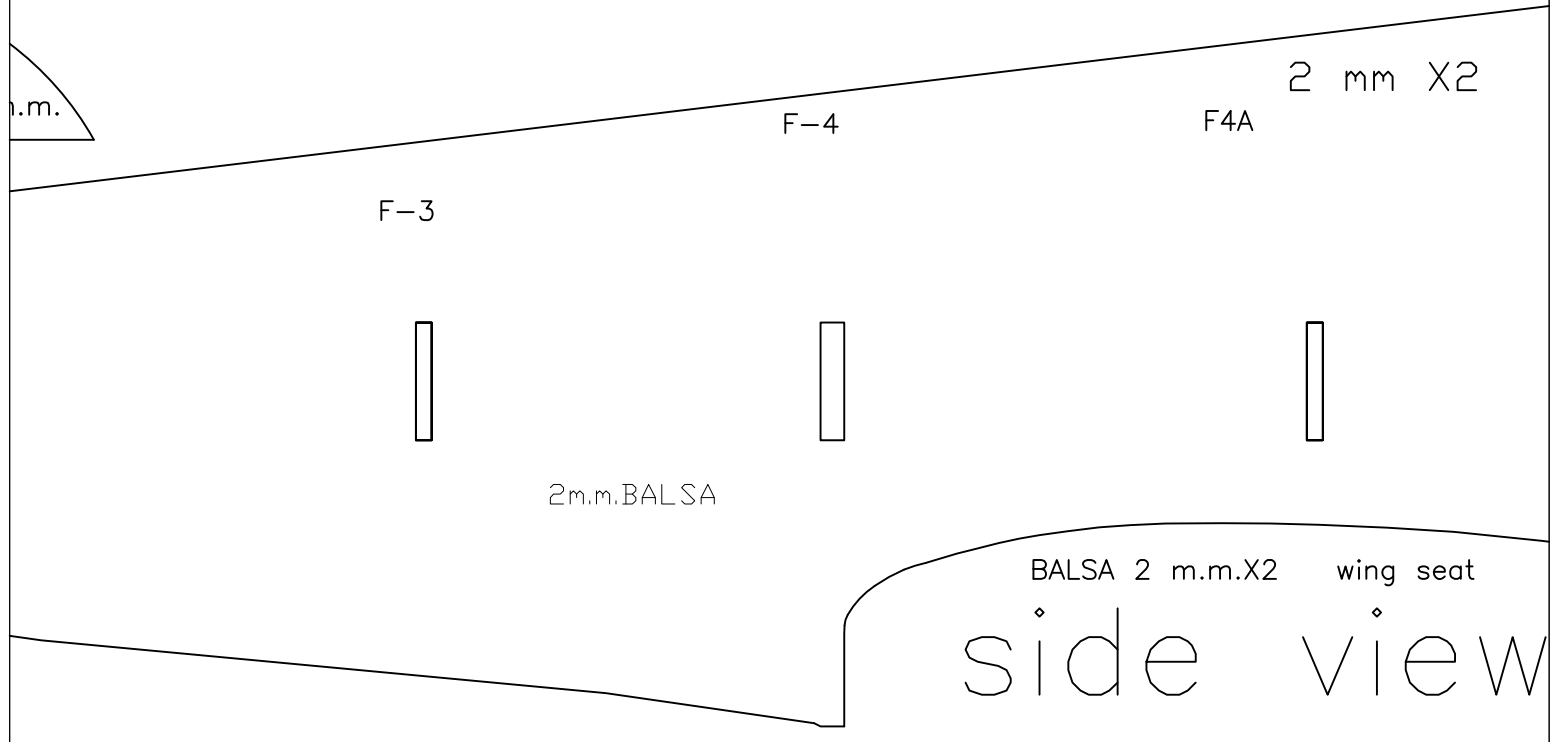

m.m.

2 mm X2

F-3

F-4

F4A

2m.m.BALSA

BALSA 2 m.m.X2 wing seat

side view

